



YOUR HEAD OFFICE FOR...

 Get advantage of the time zones to make your business work 24x7

 Reduce your workload and relax by offloading your work to us.

 Cut operational and software subscription cost.

 Get daily reports of the work assigned to us.

 Letting you focus on core activities.

Management Design **BIM Process** Texturing **Structural Analysis**
CAD Drafting Integrate **Collaboration Architectural** Planning
LOD Specifications Clash Detection As-Built Drawings ESTIMATION

Visualization
COST CONTROL
INTERIORS

Journey



- i** BIMagine Global Studio (BGS) was founded by Saurabh Kumar in 2019. While working with some of AEC companies, Saurabh observed that the potential of many young talents are not being utilized. Many of them lost their jobs in COVID pandemic as well.
- ii** An integrated team having the appropriate mix of talent, creativity and expertise was created including project managers, architects, engineers and draftsmen who use latest digital design tools and BIM process to deliver construction documents and models as per the client standards across all time zones.
- iii** This not only generated employment but also helped our overseas clients in their business growth through our remote employees. They can now focus more on the cores and adding value to their business.
- iv** Currently BGS is an Architectural and Engineering company offering all types of design solutions and virtual design construction (VDC) services which includes BIM and CAD support to its overseas clients reducing their workload and enhancing their productivity. Hence our clients spend minimum time on review cycles and get quality deliverables.



Saurabh Kumar
Founder & CEO

- ⦿ B.Tech Hons.in Civil Construction
- ⦿ Work experience in leading MNCs of AEC industry.
- ⦿ 8+ years of experience as digital design practice leader.
- ⦿ Awarded by Indian Concrete Institute and Association of Consulting Civil Engineers, India for his work on BIM.
- ⦿ Founder of " BIMagine Learning Frame " which uplift skill set of graduates and professionals in A/E industry.



BIMagine Global Studio
design powered by technology

What's Inside Our Architectural Package ?

Why Us ?

- Letting you Focus on Core Activities
- Add Value to your Business
- Cut Operational Costs & Save Big
- Add Remote Employees to your Team
- Reduce Burden of Software Cost
- Get Regular Updates on Projects



 info@bimagineglobalstudio.com

 www.bimagineglobalstudio.com

 US: +1-646-480-2113

01. Construction Documents Set

CD Set includes but not limited to :

- ✓ Site Plan
- ✓ Demolition Plan
- ✓ Existing Floor Plan
- ✓ Proposed Floor Plan
- ✓ Reflected Ceiling Plan
- ✓ Life Safety Plan
- ✓ As-Built Drawings
- ✓ Building Elevations
- ✓ Wall Sections
- ✓ Enlarge Restroom Plans
- ✓ Building Sections
- ✓ Millwork Details
- ✓ Door and Window Schedules

BIMagine is well equipped with resources to handle the project from conceptual and schematic design stage to design development and construction documentation. We produce architectural construction documents with permit set and working drawings. With a highly proficient team in AutoCAD and Revit software we provide excellent construction documentation service. We concentrate mainly on accuracy & quality of architectural construction documents.

Note : A strict quality check before delivery is followed. We follow an approach of effective communication with client and stick to the initial schedule as decided throughout the project.

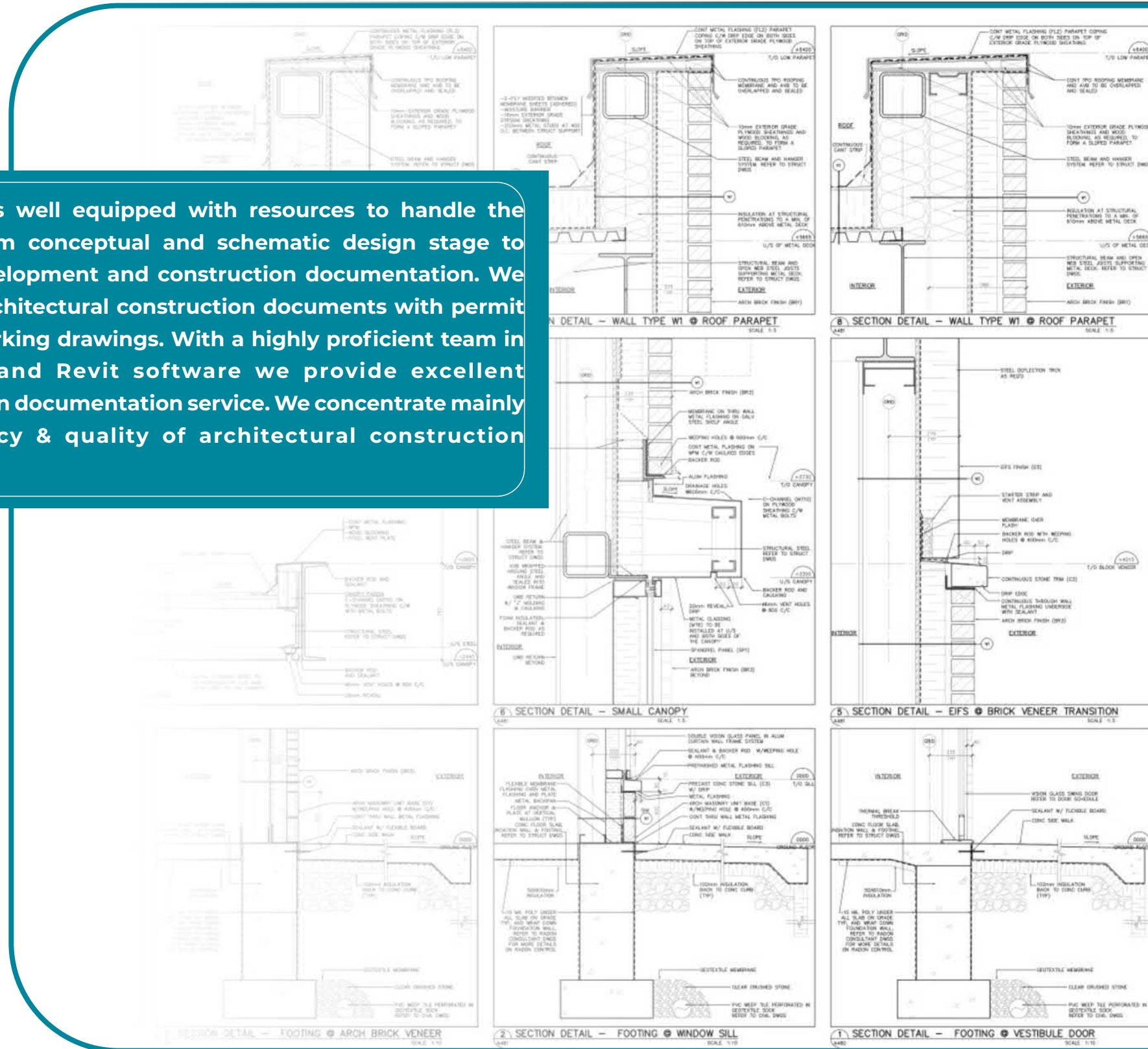

02. Architectural 3D Modeling & BIM Service

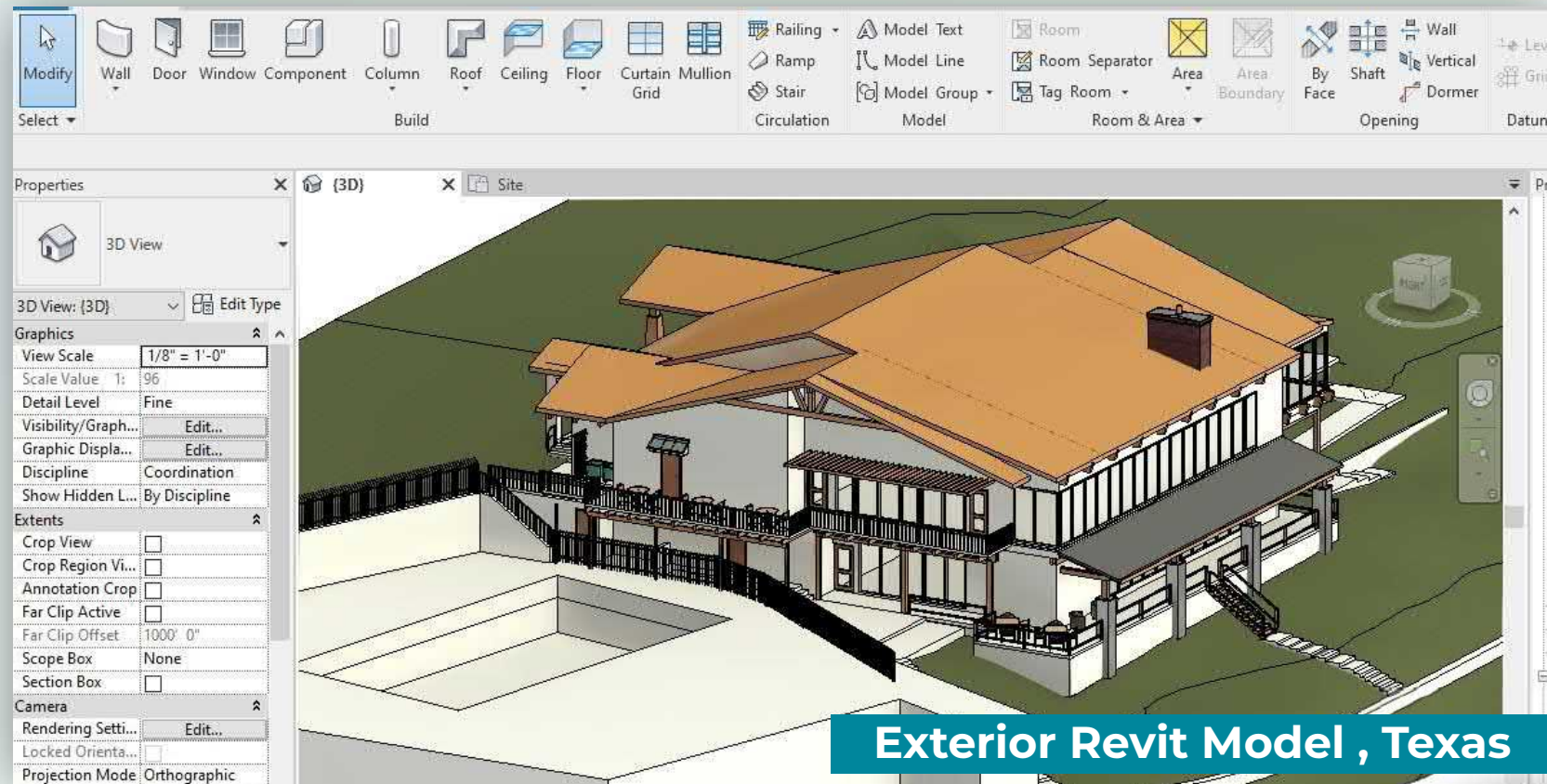

We at BIMagine provide a one point solution of all your architectural 3D & BIM Modeling needs. Our service integrates all the design changes and projects updates over the project duration to help the designers and engineers make a calculated decision. We provide a seamless and hassle-free coordination between all the project stakeholders. With the better understanding of BIM in Architecture/ Engineering/ Construction, our expertise and experience lie in developing detailed BIM Models for residential and commercial buildings, hospital and industrial, schools and other buildings of complex nature.

Architectural BIM modeling service includes :

- ✓ Architectural Revit 3D Modeling
- ✓ Architectural Exterior Modeling
- ✓ CAD to BIM Models
- ✓ Revit Family Creation
- ✓ Construction Drawings Extracted from Revit
- ✓ Scan to BIM service
- ✓ As-Built BIM modeling

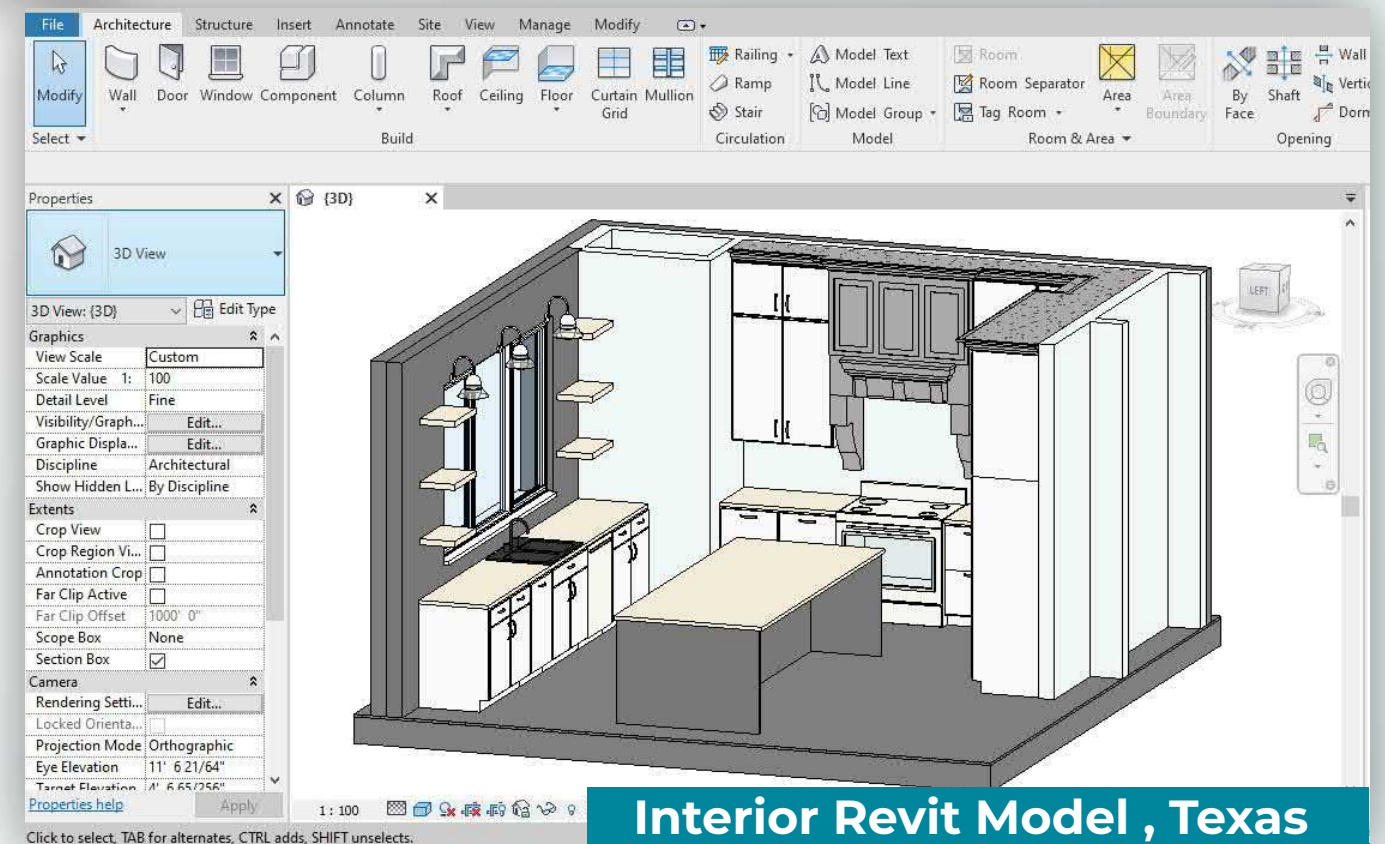

03. Renderings and Walkthroughs



Texas

“Give your Ideas a 3D Walkthrough”

This Package Includes:

- ✓ Exterior Rendering and Walkthrough
- ✓ Interior Rendering and Walkthrough
- ✓ 3D Floor Plan Rendering and Walkthrough
- ✓ Aerial View Rendering and Flythrough
- ✓ Furniture and Fixtures Rendering Services
- ✓ Assign effects of texture, lighting and shadows
- ✓ Flat Elevation Renderings



Florida



Nigeria

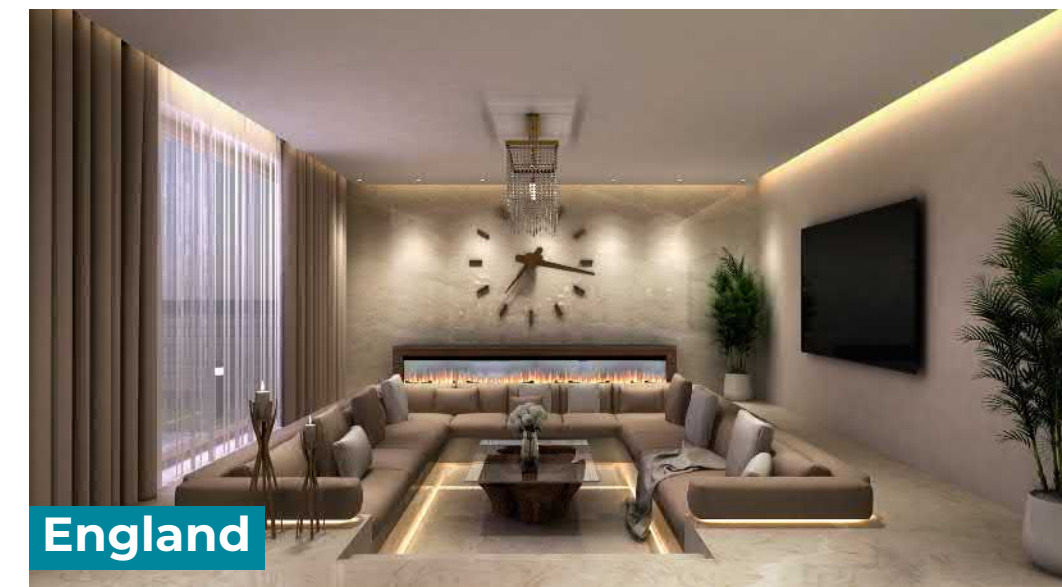

England



04. Shop Drawings

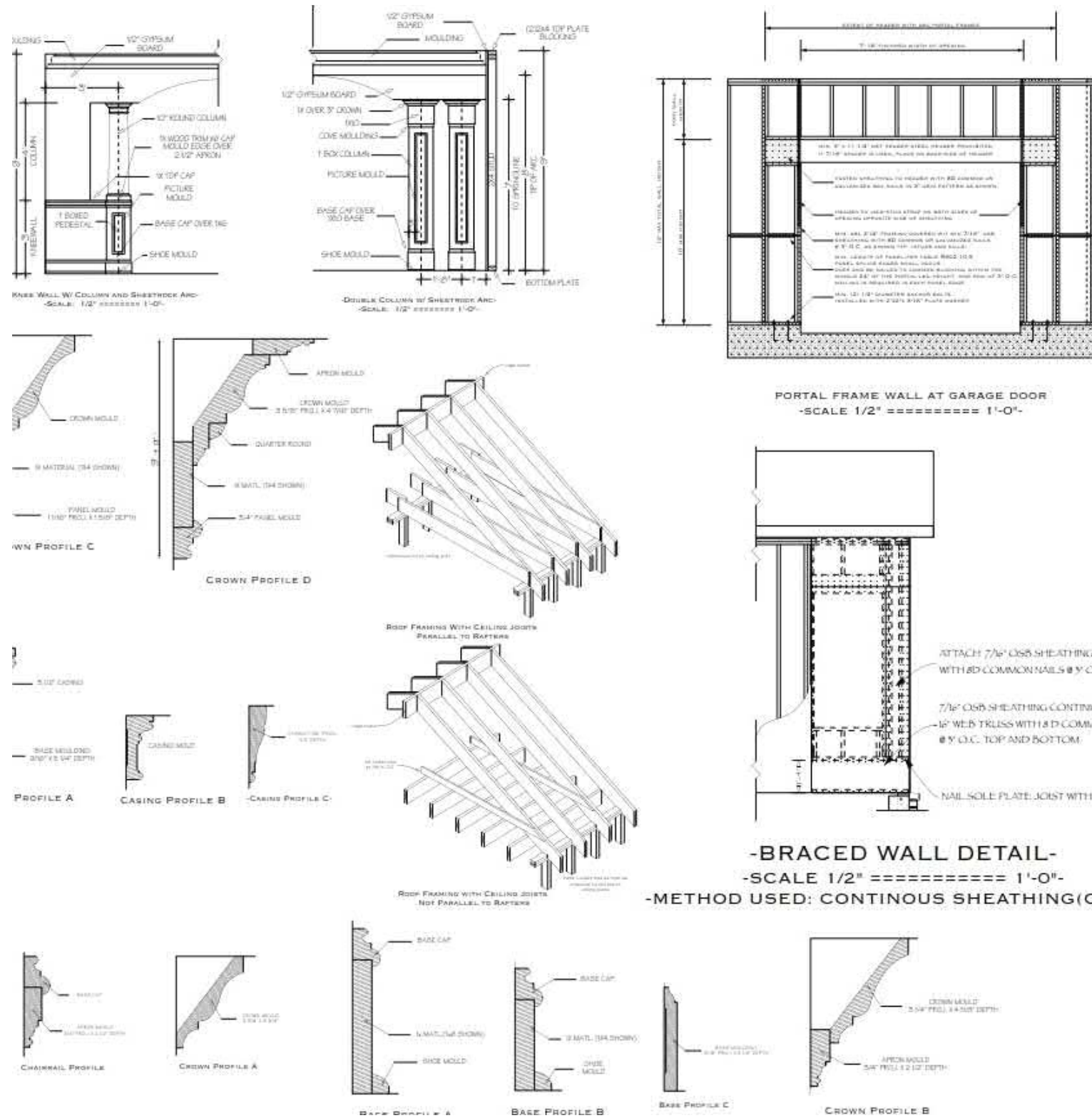

Our in-house team of experienced modelers and draftsmen can generate precise shop drawings for fabricators. For better facility management need of extracting shop drawings for different stage of construction is an important aspect. They act as a guided pathway for project completion.

This Package Includes:

- ✓ Façade Shop Drawings
- ✓ Doors and Windows Shop Drawings
- ✓ Railing Shop Drawings
- ✓ Millwork Shop Drawings
- ✓ Visual Mockups (VMU)
- ✓ Glass Shop Drawings
- ✓ Curtain Wall Shop Drawing

05. Furniture/Millwork Modeling and Detailing



This Package Includes:

- ✓ Home Furniture Modeling
- ✓ Kitchen Millwork Modeling
- ✓ Commercial Furniture Modeling
- ✓ Office Furniture Modeling
- ✓ Custom Furniture Modeling

We at BIMagine offers a furniture modeling service for all residential, office and hospitality needs. From reception to bedroom, kitchen, balcony to terrace and everything in between, we crater all your concept sketches, model them and render them to bring your visualization into reality. Our experienced team of product designers assist you to judiciously use floor space.



Texas



England





BIMagine Global Studio
design powered by technology

What's Inside Our Structural Services Package ?

Why Us ?

- Letting you Focus on Core Activities
- Add Value to your Business
- Cut Operational Costs & Save Big
- Add Remote Employees to your Team
- Reduce Burden of Software Cost
- Get Regular Updates on Projects



info@bimagineglobalstudio.com



www.bimagineglobalstudio.com



US: +1-646-480-2113

01. Structural Design

This Package Includes :

- **RC Building Design and Analysis including both commercial and residential building**
- **Steel Structure and Connections Design**
- **Truss design both steel and timber**
- **All kind of Foundation Design**
- **Ground Improvement**
- **Retaining wall design**
- **Geo-synthetic work**
- **Under-pinning**
- **Basement work**

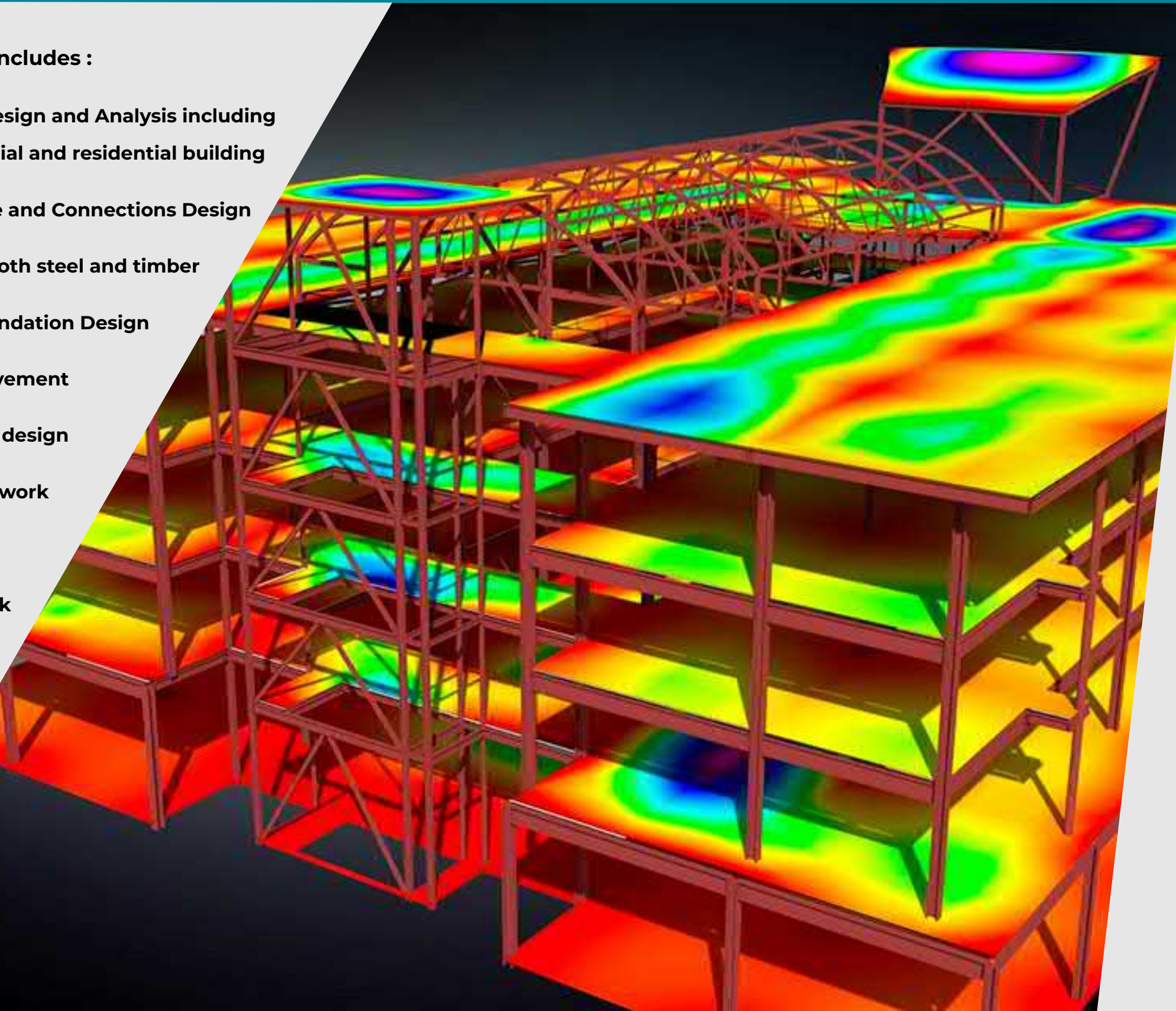

BIMagine can assist you in civil and structural engineering work from simple analysis of a member to analysis of the entire structure. Some of the structures we deal include, multistory building, bridge, and foundations. We handle both RC and steel design. Our team are familiar with following design codes:

- ✓ **ASTM**
- ✓ **IBC**
- ✓ **BS**
- ✓ **Eurocode**
- ✓ **Australian Code**
- ✓ **Canadian Code**
- ✓ **AITC 1994**
- ✓ **AISC**



02. Construction Documents Set

CD Set includes but not limited to :

- ✓ Foundation Plan
- ✓ Framing Plan
- ✓ Roof Plan
- ✓ Enlarge Structural Details
- ✓ General Arrangement Drawings
- ✓ Structural Steel Shop Drawings / Fabrication Drawings
- ✓ RC Drawings
- ✓ Wall Sections
- ✓ Assembly Drawings
- ✓ Precast Drawings
- ✓ Structural Schedule
- ✓ Bar Bending Schedules
- ✓ Water Treatment Plant Modeling and Detailing

Note: A strict quality check before delivery is followed. We follow an approach of effective communication with client and stick to the initial schedule as decided throughout the project.

BIMagine offers a wide range of structural services including structural drafting, structural steel detailing and concrete detailing services across the globe to structural engineers, steel fabricators, steel detailers, steel erectors and construction companies.

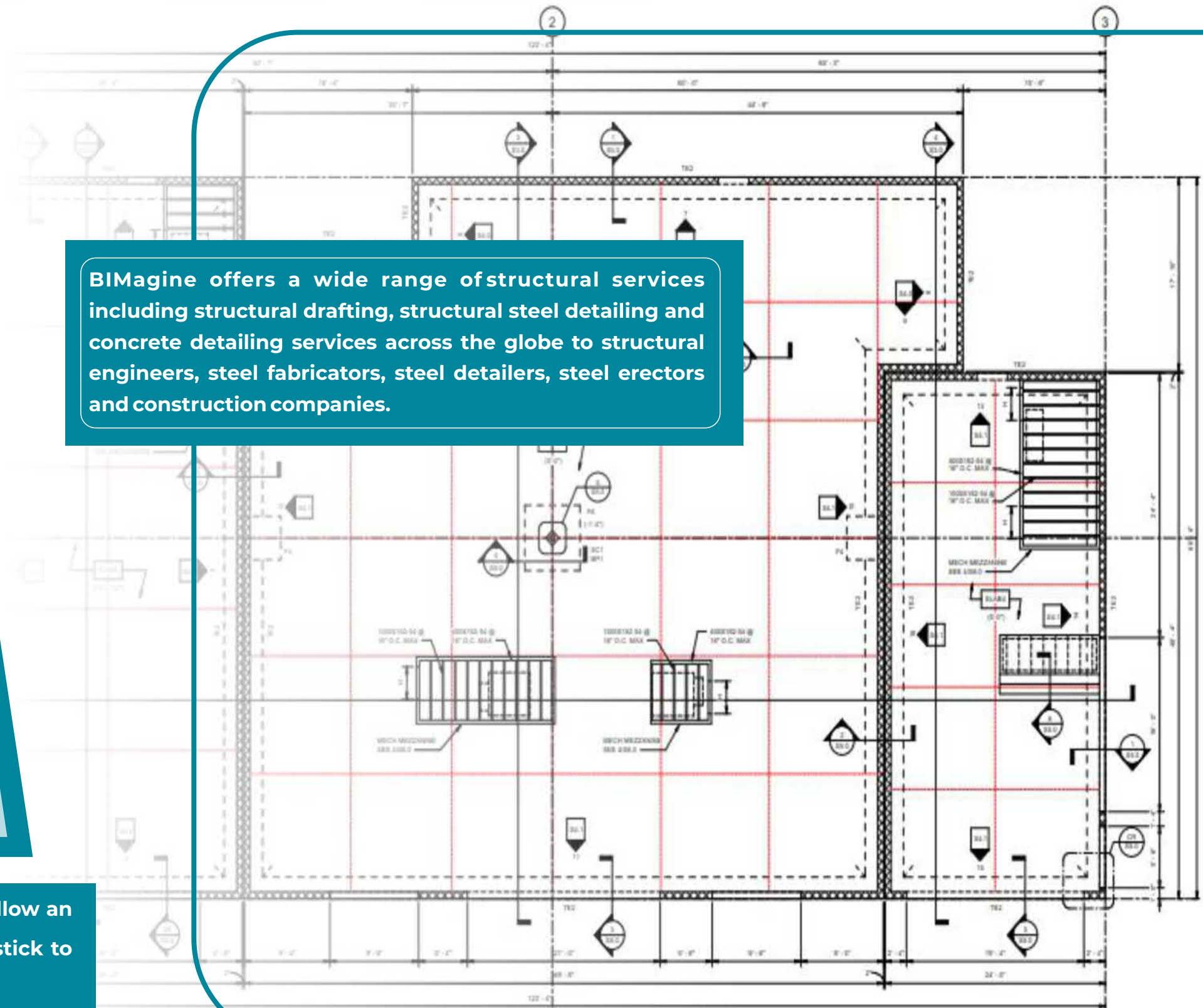

Foundation Plan

03. Structural BIM Service

Concrete Structural BIM Modeling

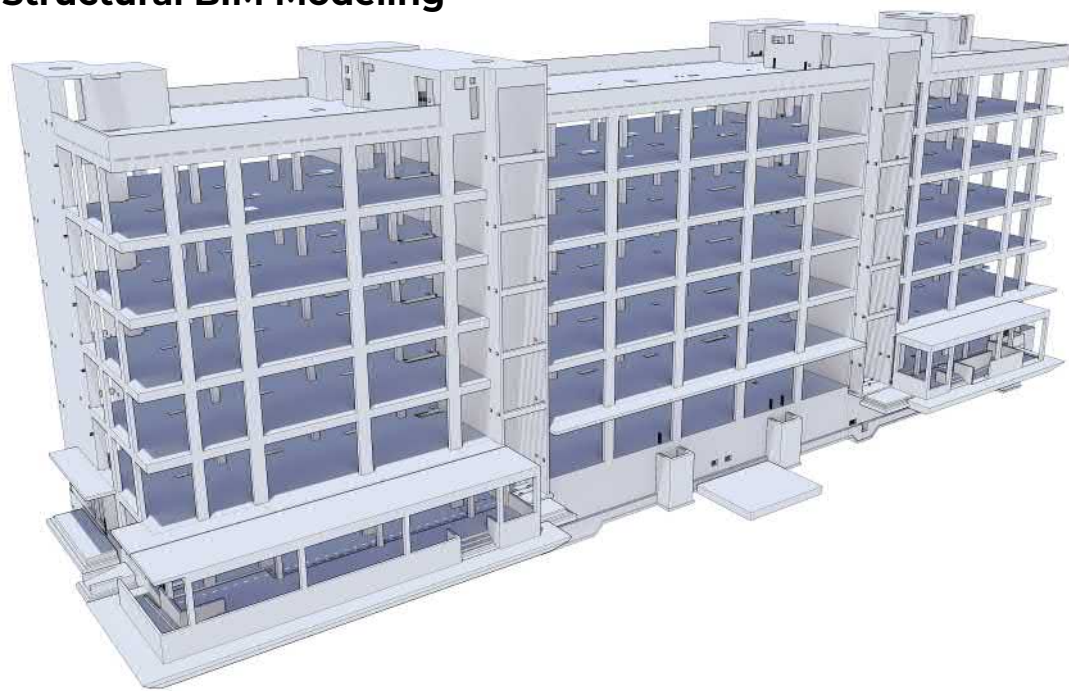

Structural BIM Service Includes :

- ✓ Coordination between BIM models (diff disciplines)
- ✓ Precast Modeling and Detailing
- ✓ Concrete Structure Modeling
- ✓ Clash Report Generation
- ✓ Structural Steel Modeling
- ✓ Wood Structures Modeling
- ✓ Drawings Extraction from BIM Models
- ✓ Scan to BIM Structural Modeling
- ✓ Revit Family Creation

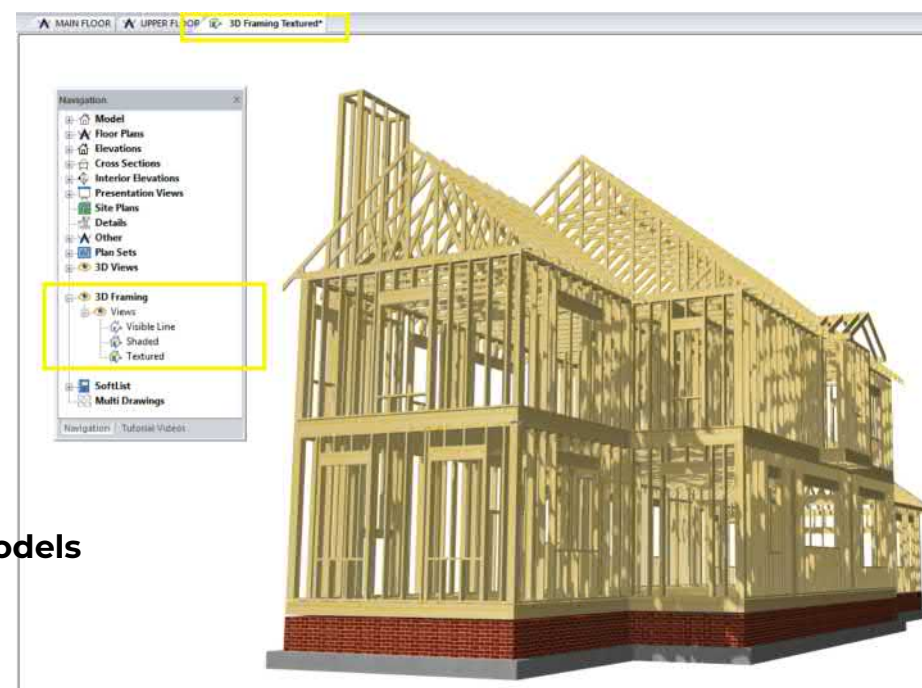

Wooden Structural BIM Modeling

Structural Steel BIM Modeling



Our expertise in BIM domain is well projected with our structural BIM service that provide improved coordination and informed decision making between contractor and structural engineer.. Our structural BIM model assist the structural consultant ,MEP consultant and architectural consultant to work with maximum efficiency by constantly updating the model with any changes in design and specification with utmost accuracy. Expertise of our structural team with Revit and other software enable us of providing structural BIM services with quick turn around time.

04. Rebar Detailing

Rebar Detailing Service Includes :

- ✓ Rebar Shop Drawings
- ✓ Bar Bending Schedule
- ✓ Retaining Wall Details
- ✓ RC Foundation Details
- ✓ 3D Rebar Modeling
- ✓ Beam , Slab and Column Rebar details
- ✓ Precast Elements Detailing

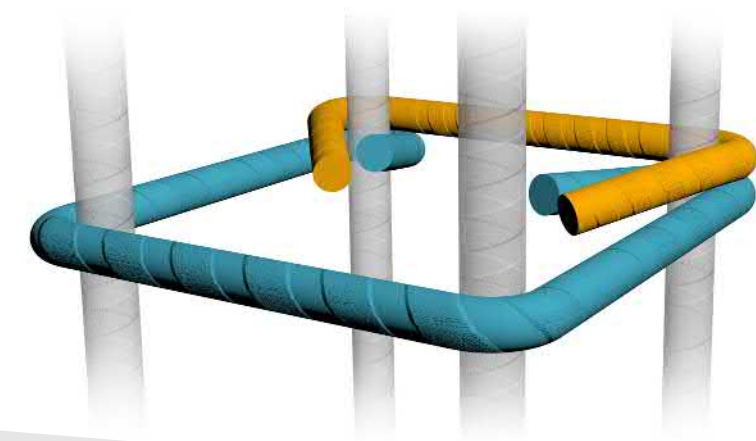
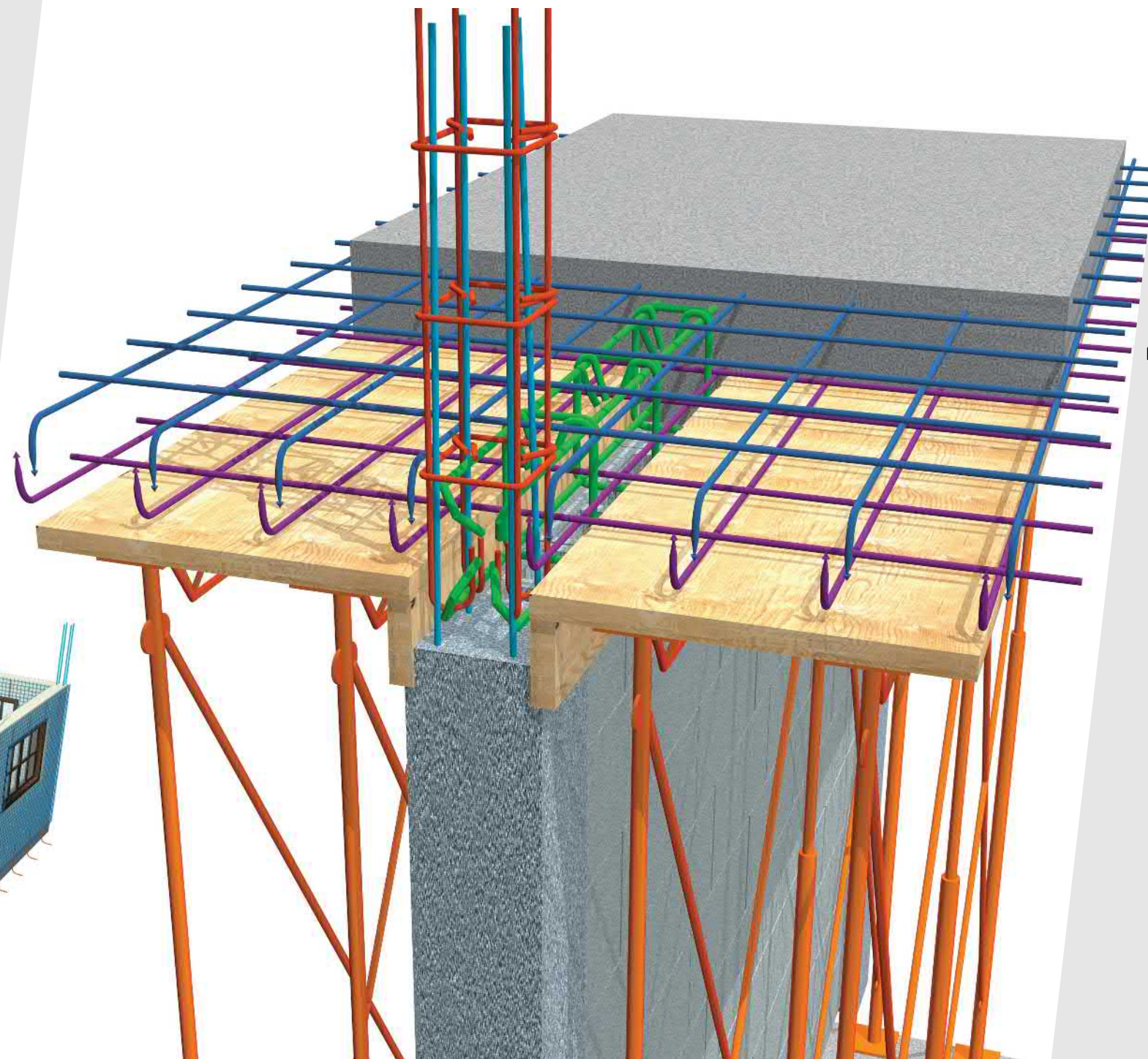

“Simplify Complex Junctions with 3D Rebar Detailing”

Rebar detailing is one of the prominent service offered by BIMagine in structural domain of services. Where the structural data is converted into detailed set of construction drawings. This service helps the client to carryout rebar laying at the site with a high level of accuracy great efficiency. Our specialized 3D Rebar Detailing Services helps the contractor to visualize the structures during construction with help of a LOD400 model in prefabrication and rebar placement on site.



06. Civil 3D Capabilities

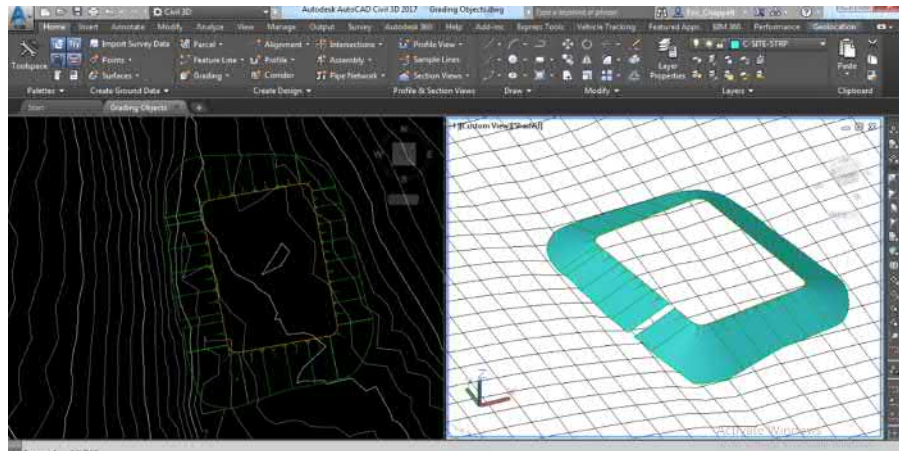

Our team of Civil 3D experts help you to deliver higher-quality transportation, land development, and environmental engineering projects faster. Their knowledge of software's purpose-built tools support building information modeling (BIM) processes and help reduce the time it takes to design, analyze, and implement changes.

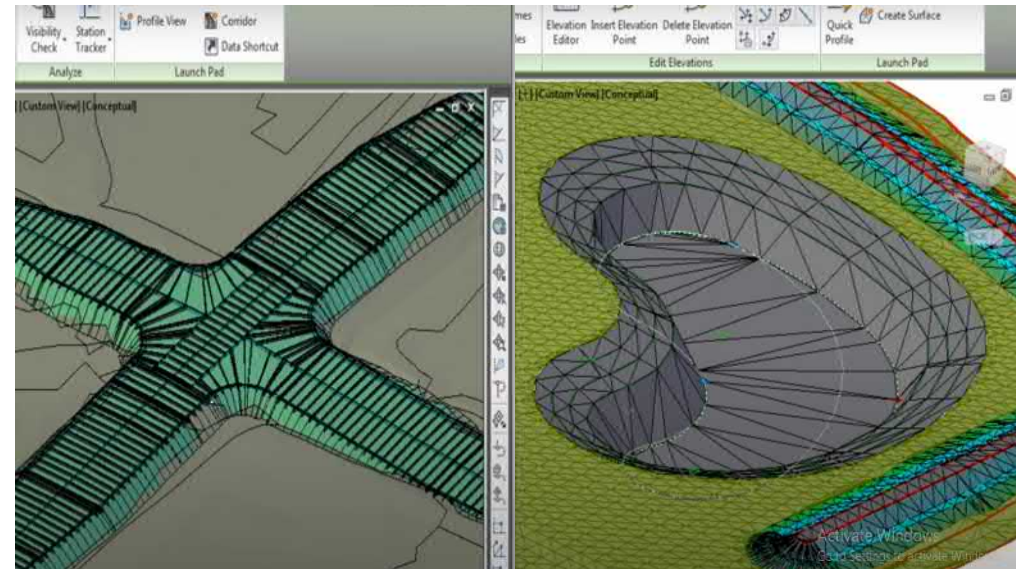
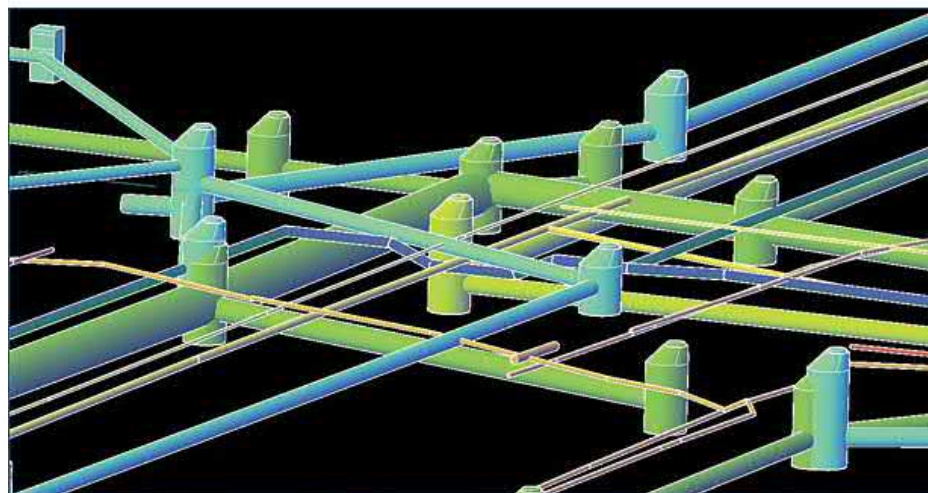

CD Set extracted from Civil 3D Includes :

- ✓ Title Sheet with Location
- ✓ Survey Drawing
- ✓ Demolition Plan
- ✓ Site Layout Plan
- ✓ Grading Plan
- ✓ Storm Water Drainage Plan and Profile
- ✓ Sewer Drainage Plan and Profile
- ✓ Utility Package Plan and Profile
- ✓ Storm Water Pollution Prevention Plan
- ✓ General Notes & Details Sheet.

This Package Includes :

- ✓ Surfaces and Grading
- ✓ Corridor Modeling
- ✓ Earthwork Calculations
- ✓ Road and Highway Alignment and Design Layout
- ✓ Quantity Takeoff Analysis:
- ✓ Pipe Networks
- ✓ Multidiscipline Coordination
- ✓ Quantity Takeoff Analysis
- ✓ Vehicle Tracking Analysis

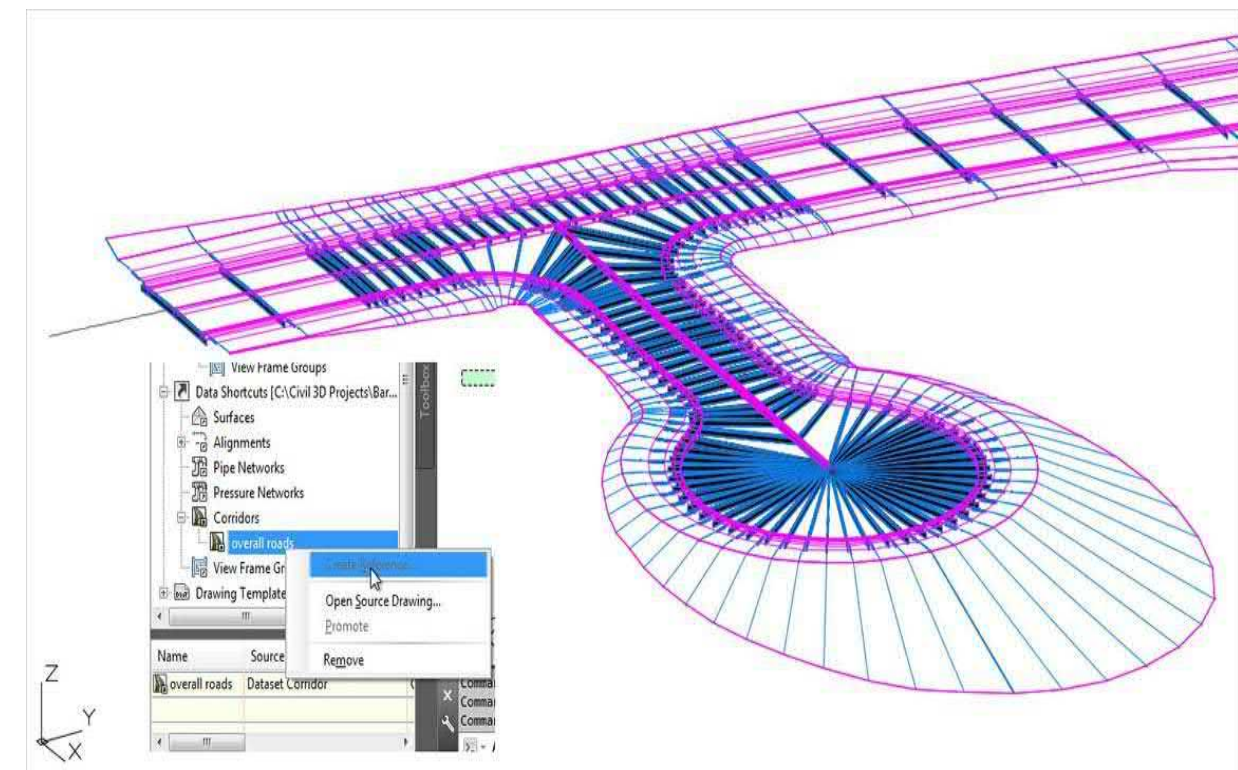



BIMagine Global Studio
design powered by technology

What's Inside MEP Services Package ?

Why Us ?

- Letting you Focus on Core Activities
- Add Value to your Business
- Cut Operational Costs & Save Big
- Add Remote Employees to your Team
- Reduce Burden of Software Cost
- Get Regular Updates on Projects



info@bimagineglobalstudio.com



www.bimagineglobalstudio.com



US: +1-646-480-2113

01. MEP Design

A. Mechanical and Plumbing Design

BIMagine provides mechanical, electrical, public health and fire protection building services design also known as building services engineering. Our LEED-accredited team of mechanical design engineers and electrical design engineers have experience in designing for new and renovated buildings in the US, UK and Australia.

Our experienced MEP design engineering professionals modify ourselves as per the client requirements deliver a range of MEP design services using the BIM process.

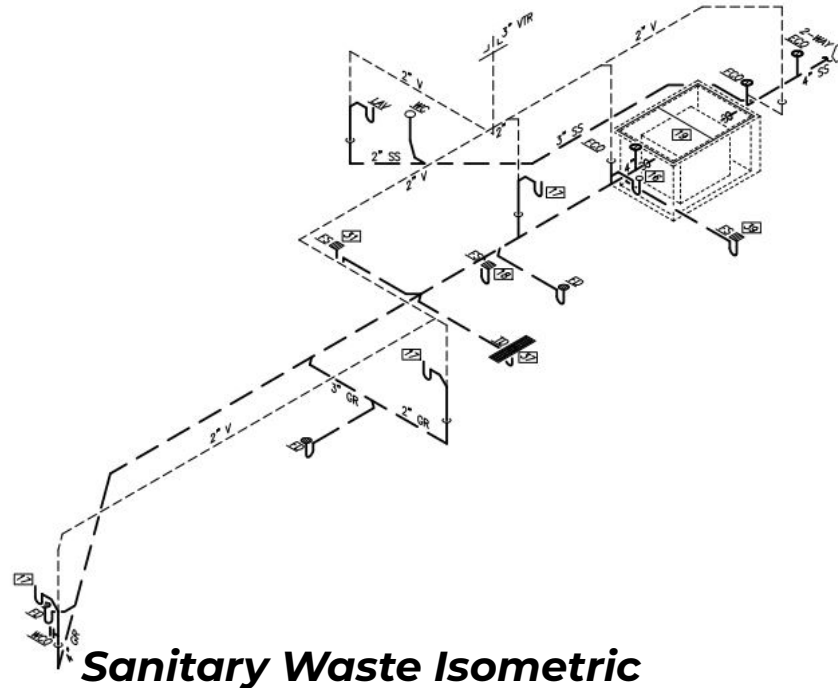

This Service Includes:

- ✓ Heating and Cooling Load Calculations by following the ASHRAE and ASME standards.
- ✓ Design and Selection of Fans / AHU / Chiller / Cooling Towers / Condenser / Pumps / FCU.
- ✓ Proposal of Cost efficient and Energy efficient HVAC Schemes of:
 - ➔ Chilled water system for both Air cooled and Water cooled Chillers.
 - ➔ Variable Refrigerant Flow System (VRF)
 - ➔ DX and Split System
- ✓ Plant Room Design and Making of BOQ .
- ✓ Pipe sizing, Duct sizing.
- ✓ HVAC, Plumbing, and Firefighting Equipment's Selection and Scheduling.
- ✓ Making of MEP Design and Shop Drawings on Auto CAD.
- ✓ Planning and Cost Estimation with problem solving & Quality Assurance skills.

B. Electrical Design Service Includes :

- ✓ Lighting System (Indoor and Outdoor) .
- ✓ Small Power Sockets.
- ✓ Electrical Load Calculations with circuit breaker selection.
- ✓ Power Cable schedules.
- ✓ Single line diagram (SLD) of distribution boards and Panels.
- ✓ ELV systems (TV, Telephone, Fire Alarm, Public Address, Access system and CCTV).
- ✓ Lightning Protection System.
- ✓ Earthing System

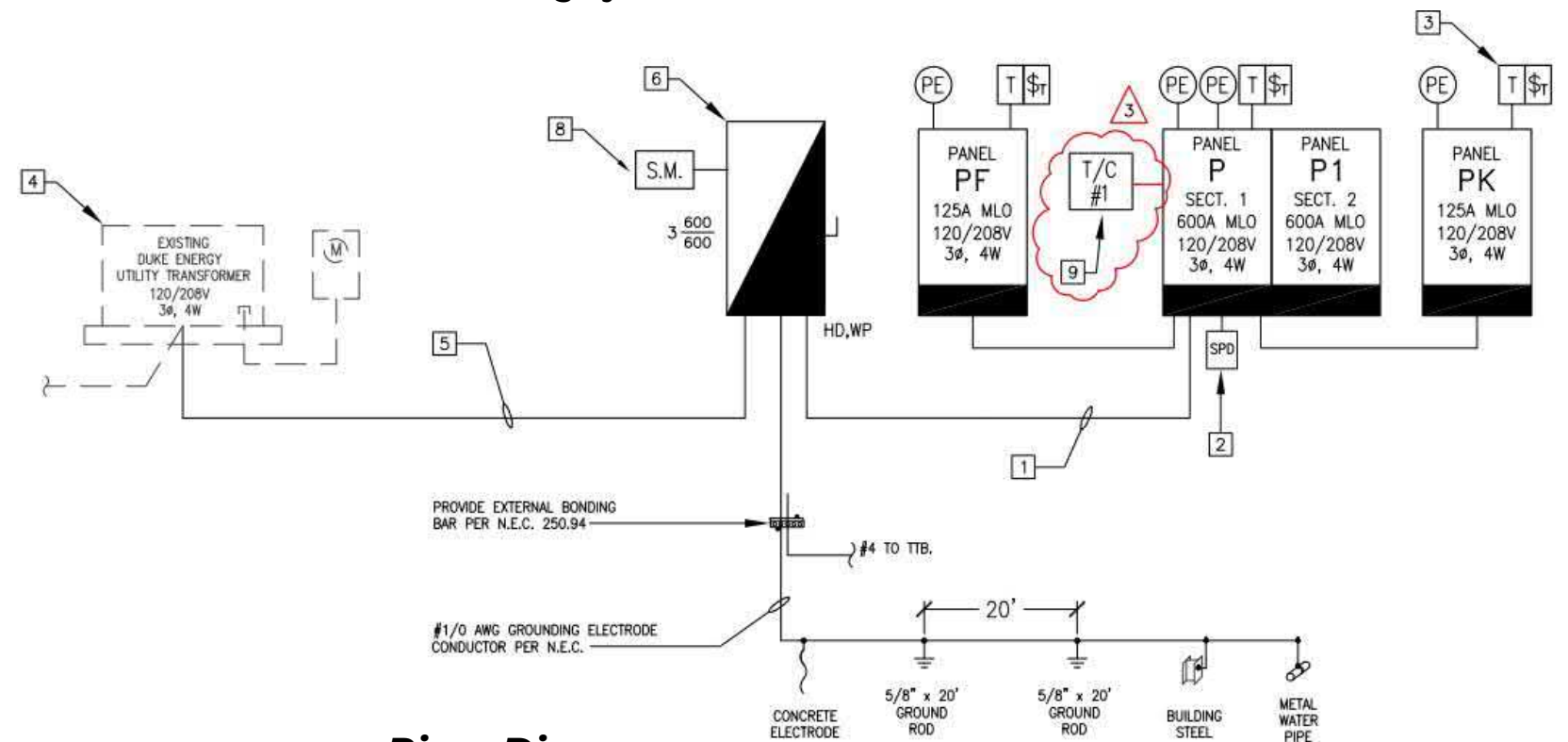

02. Construction Documents Set

At BIMagine we aim at client satisfaction by providing high quality and detailed drawings. We understand the need of precise and coordinated drawings to improve the overall performance of a construction project and make it feasible. MEP shop drawings are required to manufacture prefabricated components in MEP installation which leaves zero room for error. Our MEP experts coordinate with Services engineers to understand the needs of the site enabling them to deliver precise installation drawings for seamless fabrication onsite. We have HVAC experts who understand the technical specification of duct branches, duct cut lengths, duct and pipe insulation thicknesses, etc and provide detailed and accurate drawings on time.

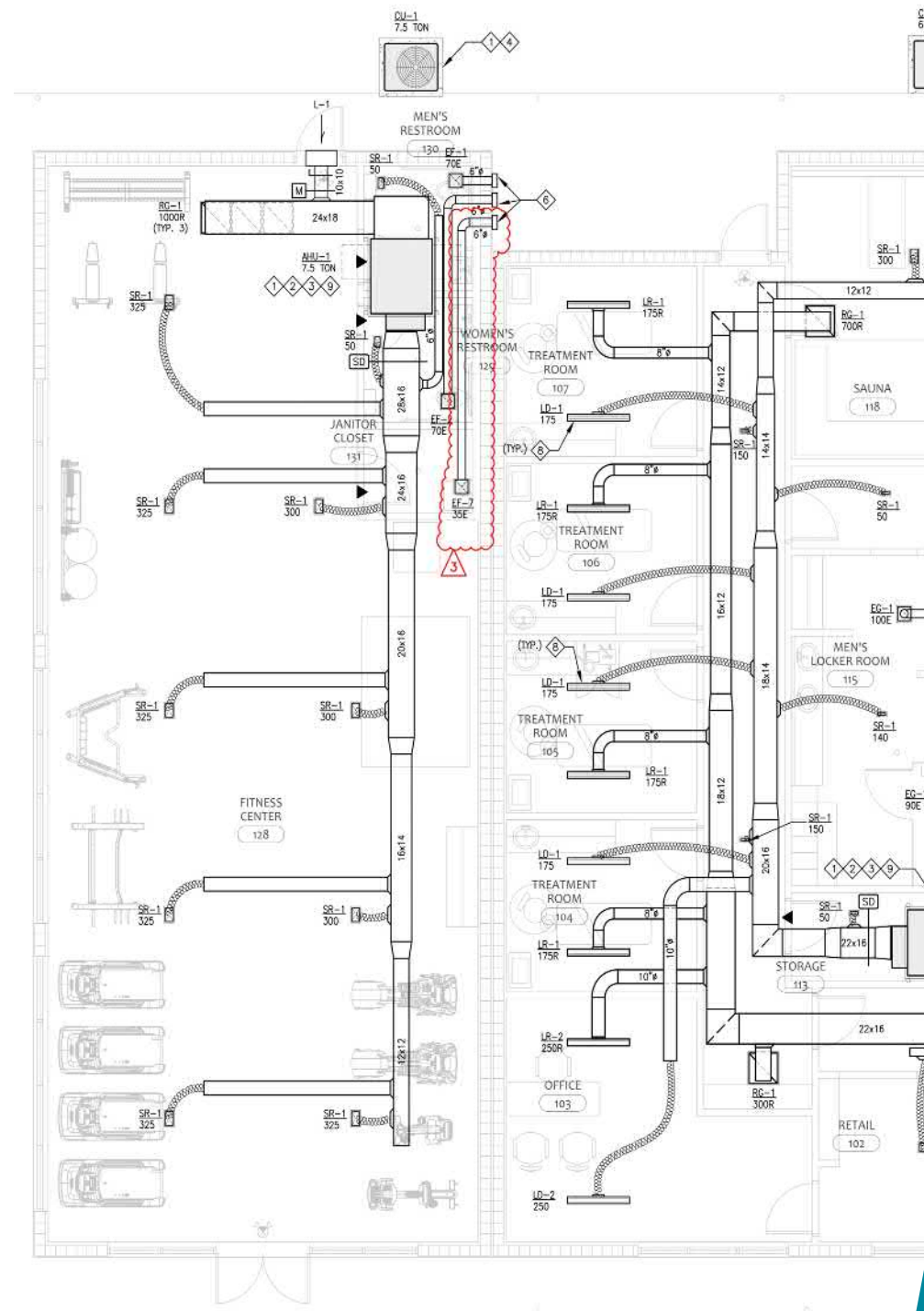

Mechanical Plan

CD Set includes but not limited to :

- ✓ **Lighting Plan**
- ✓ **Power and Systems Plan**
- ✓ **Riser Diagram and Panel Schedule**
- ✓ **Domestic Water Plan**
- ✓ **Domestic Water Isometrics**
- ✓ **Drainage, Waste and Vent Plan**
- ✓ **Plumbing Layouts and Riser Diagrams**
- ✓ **HVAC Duct Shop Drawing**
- ✓ **Mechanical piping detail drawings**
- ✓ **Mechanical Shop Drawing**
- ✓ **Duct Work Layout Drawings**

Note : A strict quality check before delivery is followed. We follow an approach of effective communication with client and stick to the initial schedule as decided throughout the project.



03. MEP BIM Service

We help MEP experts and BIM experts to rectify clashes amongst architectural, structural and MEP design of building by delivering a single coordinated model on BIM platforms to collaborate efficiently with general contractors. Along with clash detection and providing suggestions to mitigate we also provide construction scheduling videos in Navisworks to prevent any clashes during construction using our 4D BIM expertise. Our Revit MEP specialist coordinate with structural engineers and architects to coordinate designs and identify alternate designs to schedule simultaneous activities without onsite workflow clashes. We provide a detailed report regarding the clashes with alternatives and acts as per the client requirement.

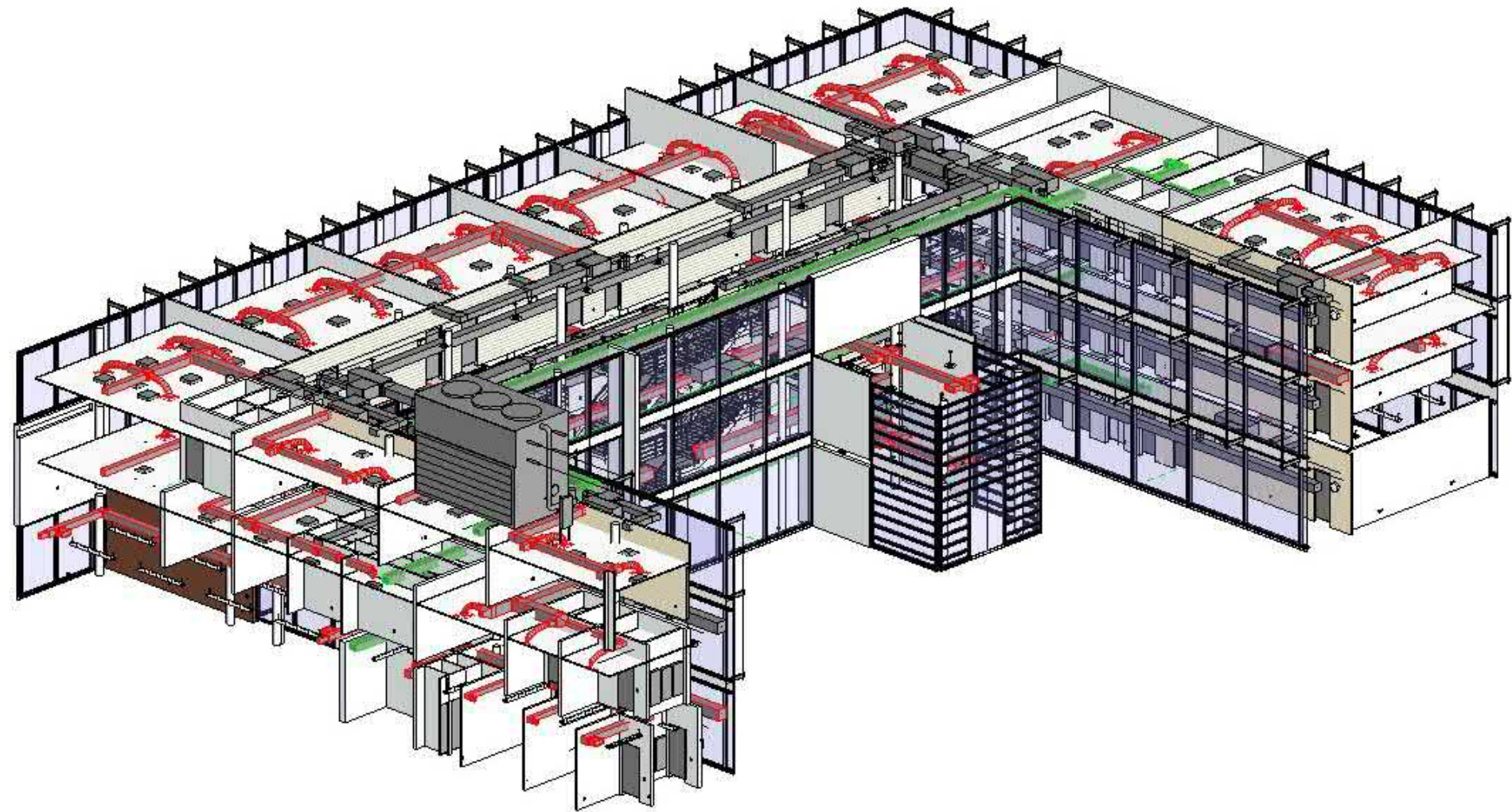

MEP BIM service includes:

- ✓ 3D MEP Modeling
- ✓ Scan to BIM Modeling
- ✓ MEP Services Clash Detection
- ✓ Extracting of Issue/Clash Report from BIM Model
- ✓ MEP Model Coordination with Architectural and Structural Disciplines
- ✓ Quantity takeoffs/Schedules Extraction
- ✓ 4D BIM Construction Phasing / 4D Timeline

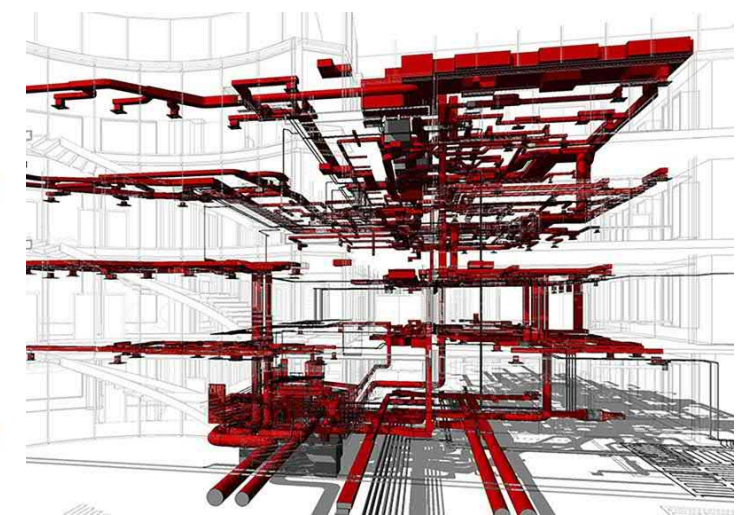
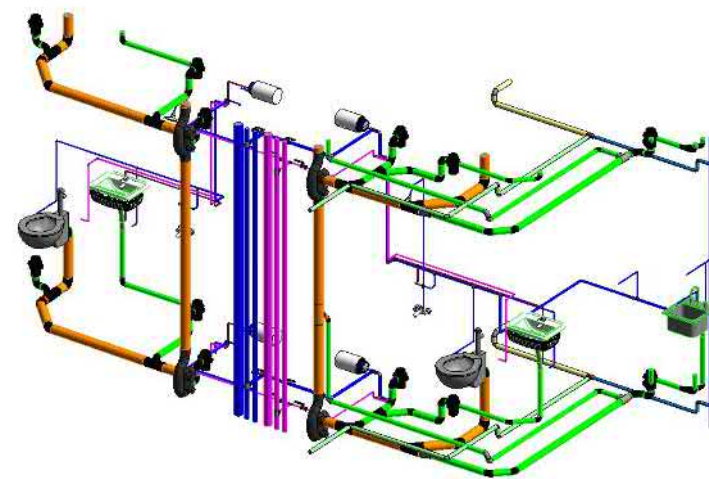
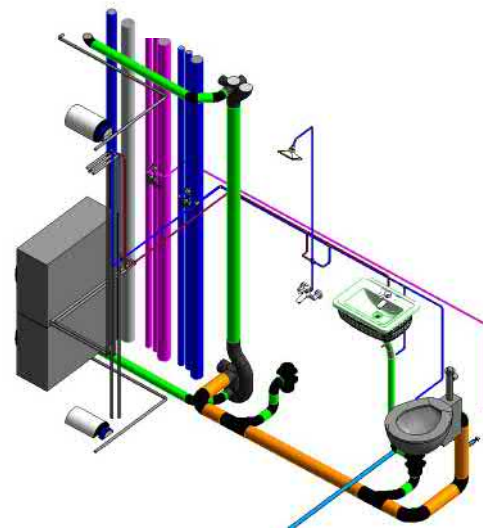

Revit MEP Modeling

How it Works

5 Step Process

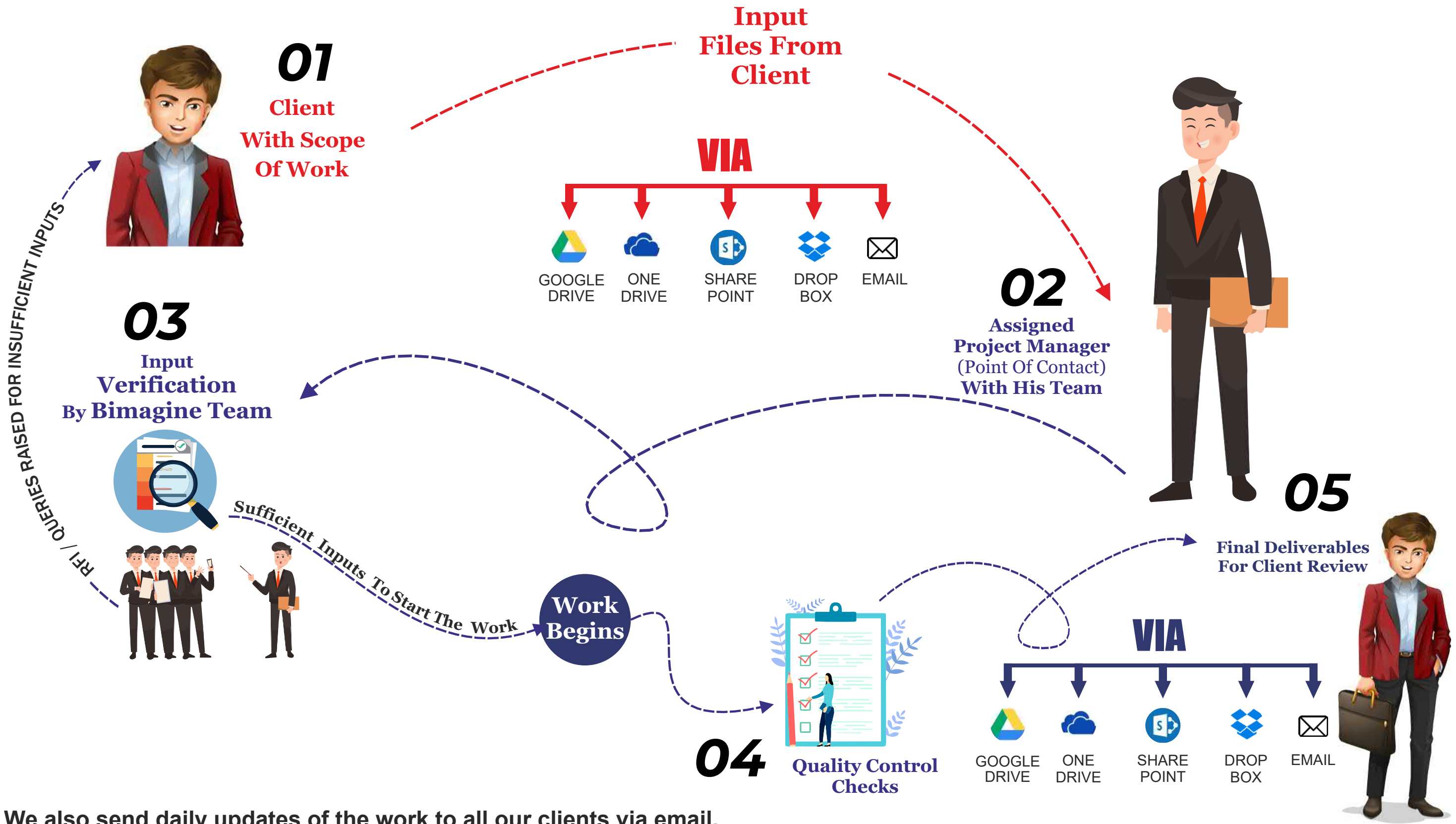

Note : We also send daily updates of the work to all our clients via email.





BIMagine Global Studio

design powered by technology

“ We would love to talk to you about any new projects you may have or any of our services you are interested in. ”



US Address

Suite No.K234 , 244, 5th Avenue New York 10001

+1-646-480-2113 | info@bimagineglobalstudio.com

India Address

B5 Wood stock, Vigyan Khand , Gomti Nagar Lucknow , Uttar Pradesh, India 226010

+91-840-155-0427

Connect • Collaborate • Construct



bimagineglobalstudio



bimagineStudio



bimagine_global_studio



bimagineglobalstudio



bimagine-global-studio